

TIMKEN

The Timken Company
4500 Mt Pleasant St. NW
N. Canton, OH 44720
Phone: (234) 262-3000

E-Mail: CustomerCAD@timken.com • Web site: www.timken.com

Part Number 3206 ATN1, Timken® Double Row Angular Contact Ball Bearings (3200, 3300)

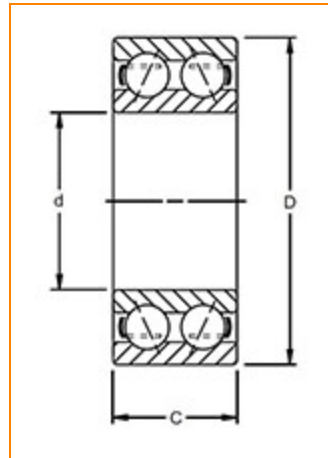

[Dimensions](#) | [Specifications](#) | [Basic Load Ratings](#) | [Abutment and Fillet Dimensions](#)

Dimensions

d - Bore	30.00 mm 1.1811 in
D - Outer Diameter	62.00 mm 2.4409 in
C - Ring Width	23.8 mm 0.9370 in
Contact Angle	30°

Specifications

Features	Open
Ball Type	STEEL
Age Type	Molded



Cage Material	Nylon
Bearing Weight	0.3 Kg 0.666 lb
Design Units	METRIC

Basic Load Ratings

C0 - Static Radial Rating	20500 N 4608 lbf
C1 ISO - Dynamic Radial Rating	28600 N 6428 lbf

Abutment and Fillet Dimensions

R - Inner Ring "To Clear" Radius ¹	1.00 mm 0.039 in
r - Outer Ring "To Clear" Radius ²	1.00 mm 0.039 in
da - Inner Ring Backing Diameter	36.0 mm 1.417 in
Da - Outer Ring Backing Diameter	56.0 mm 2.205 in

¹ Maximum housing fillet radius that bearing corners will clear.

² Maximum shaft fillet radius that bearing corners will clear.

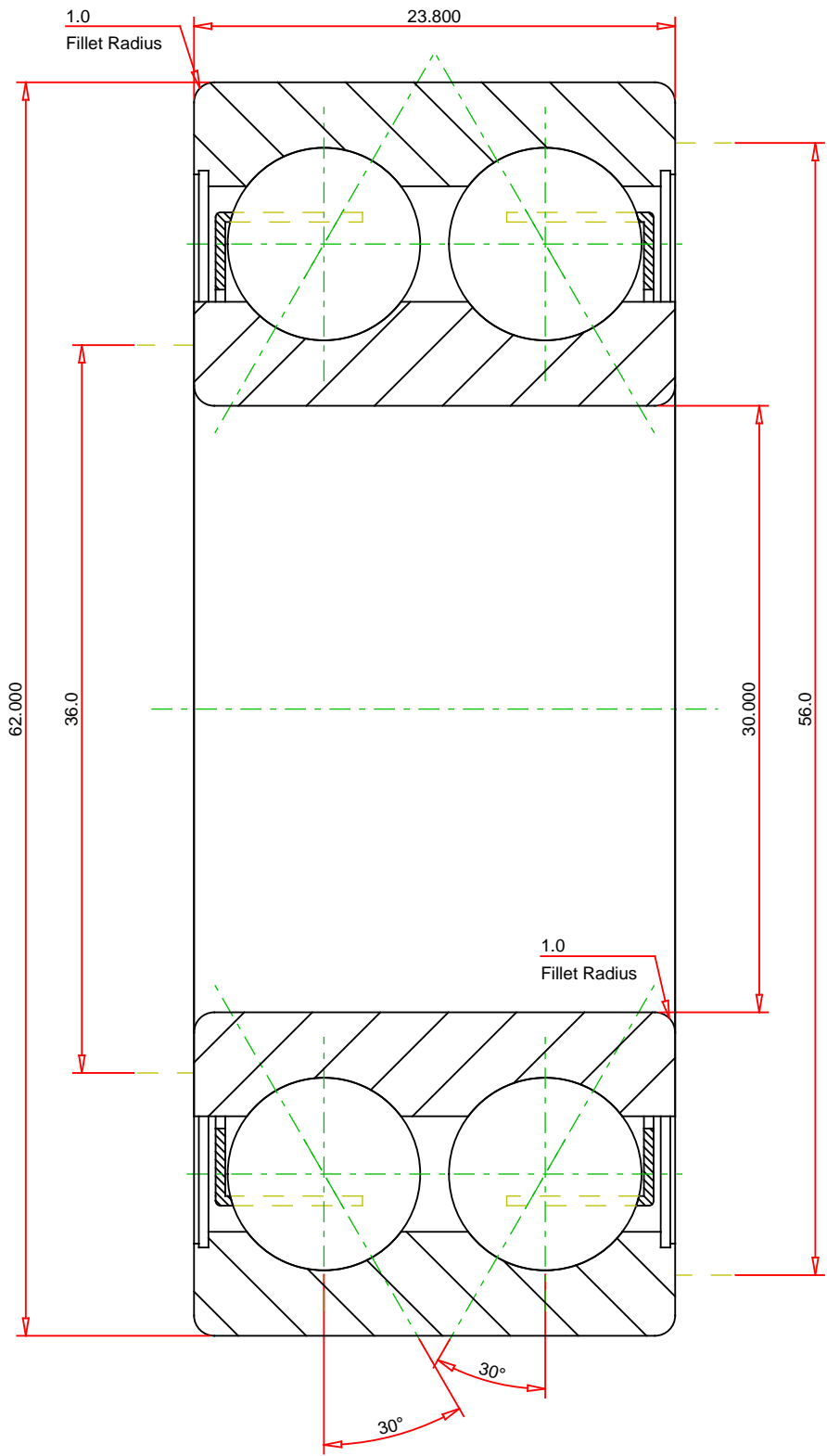

METRIC UNITS

Number of Balls Per Row	9
Bearing Weight	0.300 kg

TIMKEN®

THE TIMKEN COMPANY
NORTH CANTON, OHIO USA

3206 ATN1	
Timken® Double Row Angular Contact Ball Bearings (3200, 3300)	
Dynamic Load Rating	28600 N
Static Load Rating	20500 N

Every reasonable effort has been made to ensure the accuracy of the information contained in this writing, but no liability is accepted for errors, omissions or for any other reason.

FOR DISCUSSION ONLY